

29392

Dimensions

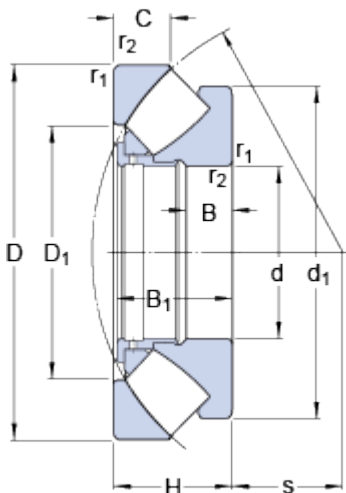

d	460	mm
D	710	mm
H	150	mm
d ₁	≈ 685	mm
D ₁	≈ 567	mm
B	50	mm
B ₁	144	mm
C	72.5	mm
s	257	mm
r _{1,2}	min. 6	mm

Abutment dimensions

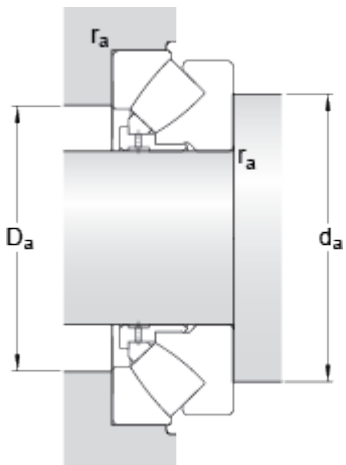

d _a	min. 585	mm
D _a	max. 630	mm
r _a	max. 5	mm

Calculation data

Basic dynamic load rating	C	4310	kN
Basic static load rating	C ₀	19000	kN
Fatigue load limit	P _u	1500	kN
Reference speed		450	r/min
Limiting speed		800	r/min
Minimum axial load factor	A	34	

Mass

Mass bearing		215	kg
--------------	--	-----	----